

# MMUN2111LT1G Series

## Bias Resistor Transistors

### PNP Silicon Surface Mount Transistors with Monolithic Bias Resistor Network

This new series of digital transistors is designed to replace a single device and its external resistor bias network. The BRT (Bias Resistor Transistor) contains a single transistor with a monolithic bias network consisting of two resistors; a series base resistor and a base-emitter resistor. The BRT eliminates these individual components by integrating them into a single device. The use of a BRT can reduce both system cost and board space. The device is housed in the SOT-23 package which is designed for low power surface mount applications.

#### Features

- Simplifies Circuit Design
- Reduces Board Space
- Reduces Component Count
- The SOT-23 package can be soldered using wave or reflow. The modified gull-winged leads absorb thermal stress during soldering eliminating the possibility of damage to the die.
- Available in 8 mm embossed tape and reel.
- These Devices are Pb-Free, Halogen Free/BFR Free and are RoHS Compliant

#### MAXIMUM RATINGS ( $T_A = 25^\circ\text{C}$ unless otherwise noted)

Rating	Symbol	Value	Unit
Collector-Base Voltage	$V_{CBO}$	50	Vdc
Collector-Emitter Voltage	$V_{CEO}$	50	Vdc
Collector Current	$I_C$	100	mAdc

#### THERMAL CHARACTERISTICS

Characteristic	Symbol	Max	Unit
Total Device Dissipation $T_A = 25^\circ\text{C}$ Derate above $25^\circ\text{C}$	$P_D$	246 (Note 1) 400 (Note 2) 2.0 (Note 1) 3.2 (Note 2)	mW mW/ $^\circ\text{C}$
Thermal Resistance, Junction-to-Ambient	$R_{\theta JA}$	508 (Note 1) 311 (Note 2)	$^\circ\text{C}/\text{W}$
Thermal Resistance, Junction-to-Lead	$R_{\theta JL}$	174 (Note 1) 208 (Note 2)	$^\circ\text{C}/\text{W}$
Junction and Storage, Temperature Range	$T_J, T_{stg}$	-55 to +150	$^\circ\text{C}$

Stresses exceeding Maximum Ratings may damage the device. Maximum Ratings are stress ratings only. Functional operation above the Recommended Operating Conditions is not implied. Extended exposure to stresses above the Recommended Operating Conditions may affect device reliability.

1. FR-4 @ Minimum Pad
2. FR-4 @ 1.0 x 1.0 inch Pad



ON Semiconductor®

<http://onsemi.com>

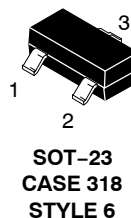
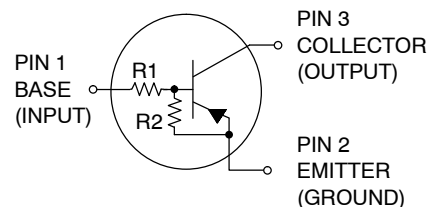

#### MARKING DIAGRAM

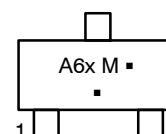

- A6x = Device Code
- x = A - L (Refer to page 2)
- M = Date Code\*
- = Pb-Free Package

(Note: Microdot may be in either location)  
\*Date Code orientation may vary depending upon manufacturing location.

#### ORDERING INFORMATION

Device	Package	Shipping†
MMUN21xxLT1G	SOT-23 (Pb-Free)	3000/Tape & Reel
MMUN21xxLT3G	SOT-23 (Pb-Free)	10000/Tape & Reel

†For information on tape and reel specifications, including part orientation and tape sizes, please refer to our Tape and Reel Packaging Specifications Brochure, BRD8011/D.

#### DEVICE MARKING INFORMATION

See specific marking information in the device marking table on page 2 of this data sheet.

## MMUN2111LT1G Series

### DEVICE MARKING AND RESISTOR VALUES

Device*	Package	Marking	R1 (K)	R2 (K)	Shipping
MMUN2111LT1G MMUN2111LT3G	SOT-23	A6A	10	10	3000/Tape & Reel 10,000/Tape & Reel
MMUN2112LT1G	SOT-23	A6B	22	22	3000/Tape & Reel
MMUN2113LT1G MMUN2113LT3G	SOT-23	A6C	47	47	3000/Tape & Reel 10,000/Tape & Reel
MMUN2114LT1G MMUN2114LT3G	SOT-23	A6D	10	47	3000/Tape & Reel 10,000/Tape & Reel
MMUN2115LT1G	SOT-23	A6E	10	∞	3000/Tape & Reel
MMUN2116LT1G	SOT-23	A6F	4.7	∞	3000/Tape & Reel
MMUN2130LT1G (Note 3)	SOT-23	A6G	1.0	1.0	3000/Tape & Reel
MMUN2131LT1G (Note 3)	SOT-23	A6H	2.2	2.2	3000/Tape & Reel
MMUN2132LT1G	SOT-23	A6J	4.7	4.7	3000/Tape & Reel
MMUN2133LT1G	SOT-23	A6K	4.7	47	3000/Tape & Reel
MMUN2134LT1G (Note 3)	SOT-23	A6L	22	47	3000/Tape & Reel

\*The "G" suffix indicates Pb-Free package available.

3. New devices. Updated curves to follow in subsequent data sheets.

### ELECTRICAL CHARACTERISTICS ( $T_A = 25^\circ\text{C}$ unless otherwise noted)

Characteristic	Symbol	Min	Typ	Max	Unit
<b>OFF CHARACTERISTICS</b>					
Collector-Base Cutoff Current ( $V_{CB} = 50\text{ V}$ , $I_E = 0$ )	$I_{CBO}$	-	-	100	nAdc
Collector-Emitter Cutoff Current ( $V_{CE} = 50\text{ V}$ , $I_B = 0$ )	$I_{CEO}$	-	-	500	nAdc
Emitter-Base Cutoff Current ( $V_{EB} = 6.0\text{ V}$ , $I_C = 0$ )	$I_{EBO}$	-	-	0.5	mAdc
	MMUN2111LT1G	-	-	0.2	
	MMUN2112LT1G	-	-	0.1	
	MMUN2113LT1G	-	-	0.2	
	MMUN2114LT1G	-	-	0.9	
	MMUN2115LT1G	-	-	1.9	
	MMUN2116LT1G	-	-	4.3	
	MMUN2130LT1G	-	-	2.3	
	MMUN2131LT1G	-	-	1.5	
	MMUN2132LT1G	-	-	0.18	
	MMUN2133LT1G	-	-	0.13	
	MMUN2134LT1G	-	-		
Collector-Base Breakdown Voltage ( $I_C = 10\ \mu\text{A}$ , $I_E = 0$ )	$V_{(BR)CBO}$	50	-	-	Vdc
Collector-Emitter Breakdown Voltage (Note 4) ( $I_C = 2.0\text{ mA}$ , $I_B = 0$ )	$V_{(BR)CEO}$	50	-	-	Vdc

4. Pulse Test: Pulse Width < 300  $\mu\text{s}$ , Duty Cycle < 2.0%

## MMUN2111LT1G Series

### ELECTRICAL CHARACTERISTICS ( $T_A = 25^\circ\text{C}$ unless otherwise noted) (Continued)

Characteristic	Symbol	Min	Typ	Max	Unit
<b>ON CHARACTERISTICS</b> (Note 5)					
DC Current Gain ( $V_{CE} = 10\text{ V}$ , $I_C = 5.0\text{ mA}$ )	MMUN2111LT1G	35	60	–	
	MMUN2112LT1G	60	100	–	
	MMUN2113LT1G	80	140	–	
	MMUN2114LT1G	80	140	–	
	MMUN2115LT1G	160	250	–	
	MMUN2116LT1G	160	250	–	
	MMUN2130LT1G	3.0	5.0	–	
	MMUN2131LT1G	8.0	15	–	
	MMUN2132LT1G	15	27	–	
	MMUN2133LT1G	80	140	–	
	MMUN2134LT1G	80	130	–	
Collector-Emitter Saturation Voltage ( $I_C = 10\text{ mA}$ , $I_B = 0.3\text{ mA}$ )  ( $I_C = 10\text{ mA}$ , $I_B = 5\text{ mA}$ )  ( $I_C = 10\text{ mA}$ , $I_B = 1\text{ mA}$ )	MMUN2111LT1G	–	–	0.25	Vdc
	MMUN2112LT1G	–	–	0.25	
	MMUN2113LT1G	–	–	0.25	
	MMUN2114LT1G	–	–	0.25	
	MMUN2133LT1G	–	–	0.25	
	MMUN2130LT1G	–	–	0.25	
	MMUN2131LT1G	–	–	0.25	
	MMUN2115LT1G	–	–	0.25	
	MMUN2116LT1G	–	–	0.25	
	MMUN2132LT1G	–	–	0.25	
	MMUN2134LT1G	–	–	0.25	
Output Voltage (on) ( $V_{CC} = 5.0\text{ V}$ , $V_B = 2.5\text{ V}$ , $R_L = 1.0\text{ k}\Omega$ )          ( $V_{CC} = 5.0\text{ V}$ , $V_B = 3.5\text{ V}$ , $R_L = 1.0\text{ k}\Omega$ )	MMUN2111LT1G	–	–	0.2	Vdc
	MMUN2112LT1G	–	–	0.2	
	MMUN2114LT1G	–	–	0.2	
	MMUN2115LT1G	–	–	0.2	
	MMUN2116LT1G	–	–	0.2	
	MMUN2130LT1G	–	–	0.2	
	MMUN2131LT1G	–	–	0.2	
	MMUN2132LT1G	–	–	0.2	
	MMUN2133LT1G	–	–	0.2	
	MMUN2134LT1G	–	–	0.2	
	MMUN2113LT1G	–	–	0.2	
Output Voltage (off) ( $V_{CC} = 5.0\text{ V}$ , $V_B = 0.5\text{ V}$ , $R_L = 1.0\text{ k}\Omega$ )      ( $V_{CC} = 5.0\text{ V}$ , $V_B = 0.25\text{ V}$ , $R_L = 1.0\text{ k}\Omega$ )     ( $V_{CC} = 5.0\text{ V}$ , $V_B = 0.050\text{ V}$ , $R_L = 1.0\text{ k}\Omega$ )	MMUN2111LT1G	4.9	–	–	Vdc
	MMUN2112LT1G	4.9	–	–	
	MMUN2113LT1G	4.9	–	–	
	MMUN2114LT1G	4.9	–	–	
	MMUN2133LT1G	4.9	–	–	
	MMUN2134LT1G	4.9	–	–	
	MMUN2115LT1G	4.9	–	–	
	MMUN2116LT1G	4.9	–	–	
	MMUN2131LT1G	4.9	–	–	
	MMUN2132LT1G	4.9	–	–	
	MMUN2130LT1G	4.9	–	–	

## MMUN2111LT1G Series

### ELECTRICAL CHARACTERISTICS ( $T_A = 25^\circ\text{C}$ unless otherwise noted) (Continued)

Characteristic		Symbol	Min	Typ	Max	Unit
<b>ON CHARACTERISTICS</b> (Note 5)						
Input Resistor	MMUN2111LT1G	R1	7.0	10	13	k $\Omega$
	MMUN2112LT1G		15.4	22	28.6	
	MMUN2113LT1G		32.9	47	61.1	
	MMUN2114LT1G		7.0	10	13	
	MMUN2115LT1G		7.0	10	13	
	MMUN2116LT1G		3.3	4.7	6.1	
	MMUN2130LT1G		0.7	1.0	1.3	
	MMUN2131LT1G		1.5	2.2	2.9	
	MMUN2132LT1G		3.3	4.7	6.1	
	MMUN2133LT1G		3.3	4.7	6.1	
MMUN2134LT1G	15.4	22	28.6			
Resistor Ratio	MMUN2111LT1G	$R_1/R_2$	0.8	1.0	1.2	
	MMUN2112LT1G		0.8	1.0	1.2	
	MMUN2113LT1G		0.8	1.0	1.2	
	MMUN2114LT1G		0.17	0.21	0.25	
	MMUN2115LT1G		-	-	-	
	MMUN2116LT1G		-	-	-	
	MMUN2130LT1G		0.8	1.0	1.2	
	MMUN2131LT1G		0.8	1.0	1.2	
	MMUN2132LT1G		0.8	1.0	1.2	
	MMUN2133LT1G		0.055	0.1	0.185	
MMUN2134LT1G	0.38	0.47	0.56			

5. Pulse Test: Pulse Width < 300  $\mu\text{s}$ , Duty Cycle < 2.0%

# MMUN2111LT1G Series

## TYPICAL ELECTRICAL CHARACTERISTICS MMUN2111LT1

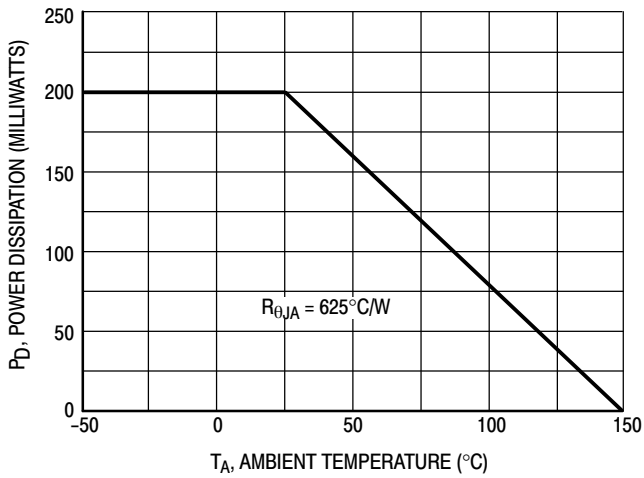

Figure 1. Derating Curve

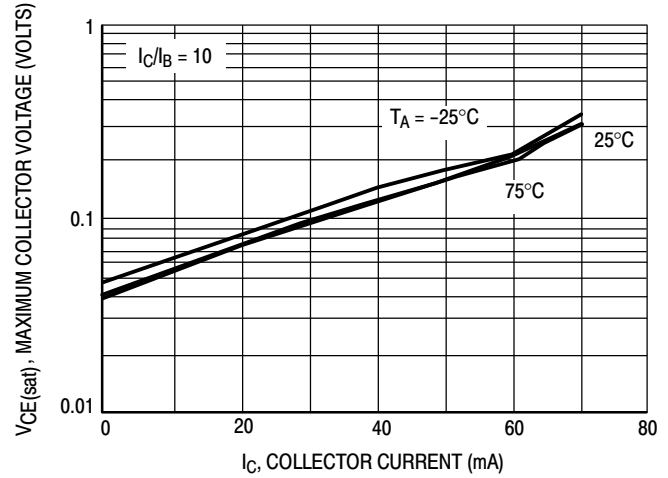

Figure 2. V<sub>CE(sat)</sub> versus I<sub>C</sub>

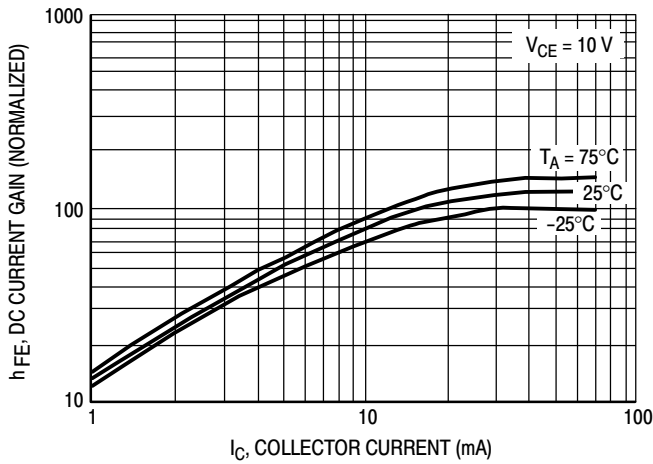

Figure 3. DC Current Gain

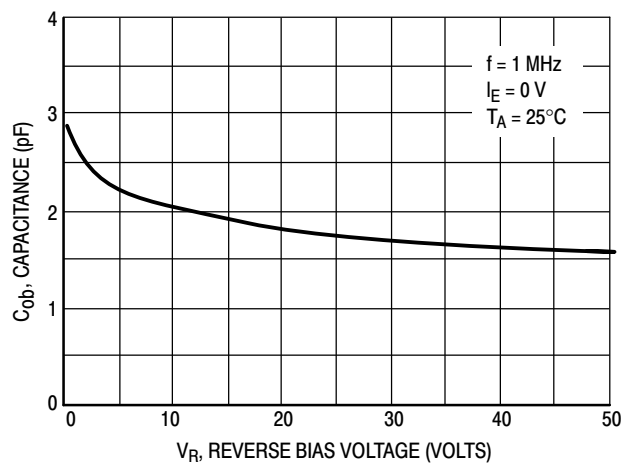

Figure 4. Output Capacitance

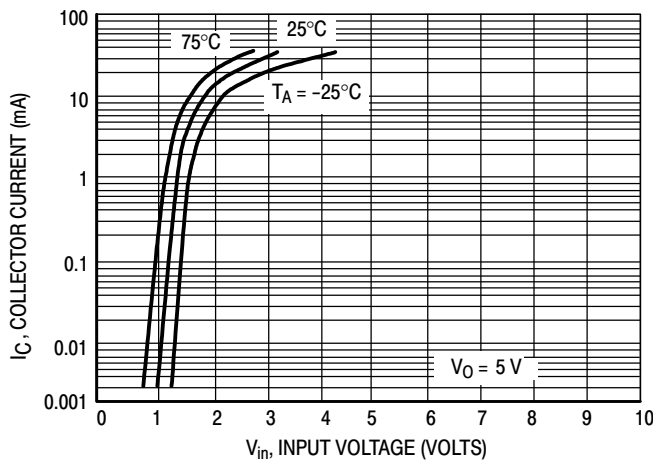

Figure 5. Output Current versus Input Voltage

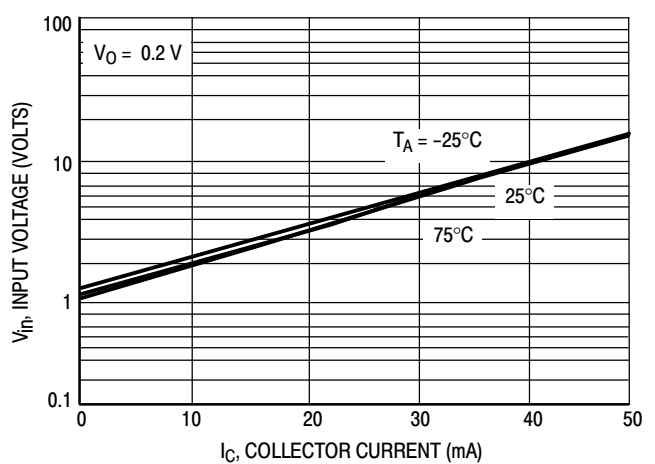

Figure 6. Input Voltage versus Output Current

# MMUN2111LT1G Series

## TYPICAL ELECTRICAL CHARACTERISTICS MMUN2112LT1

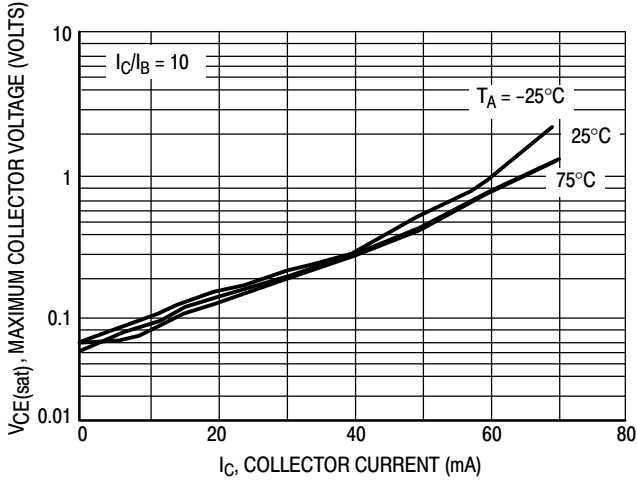

Figure 7.  $V_{CE(sat)}$  versus  $I_C$

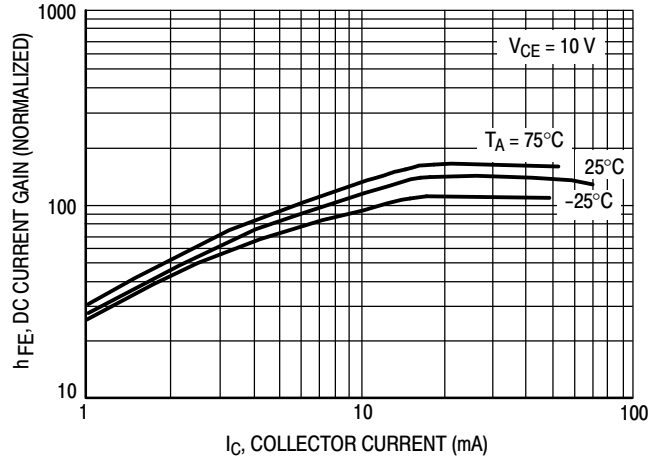

Figure 8. DC Current Gain

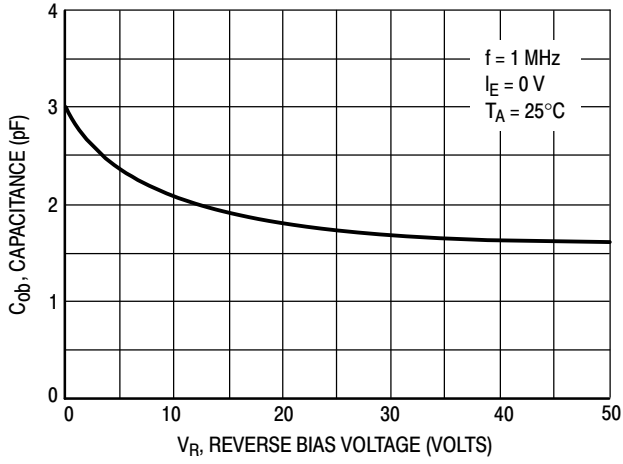

Figure 9. Output Capacitance

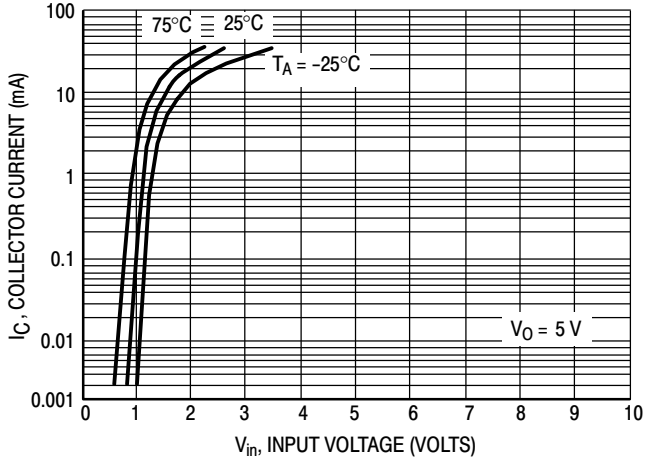

Figure 10. Output Current versus Input Voltage

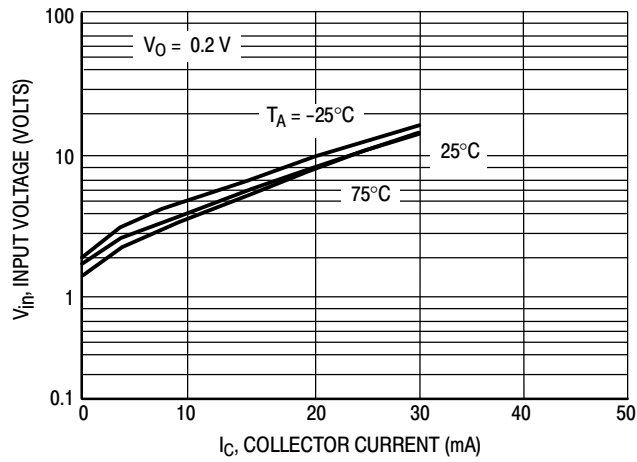

Figure 11. Input Voltage versus Output Current

# MMUN2111LT1G Series

## TYPICAL ELECTRICAL CHARACTERISTICS MMUN2113LT1

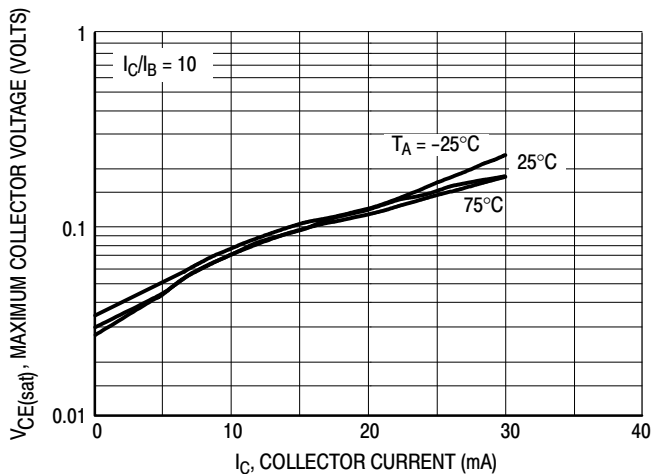

Figure 12.  $V_{CE(sat)}$  versus  $I_C$

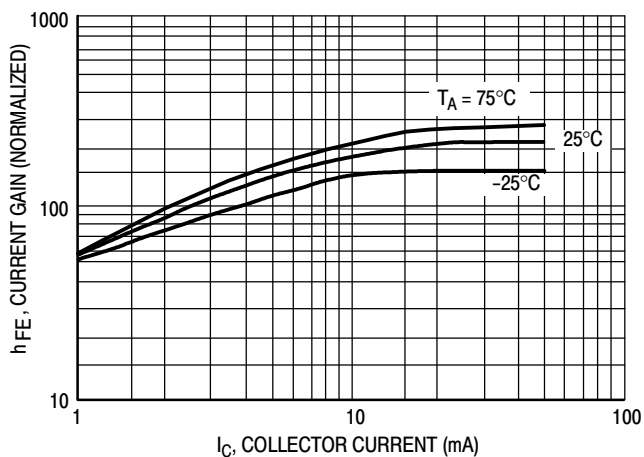

Figure 13. DC Current Gain

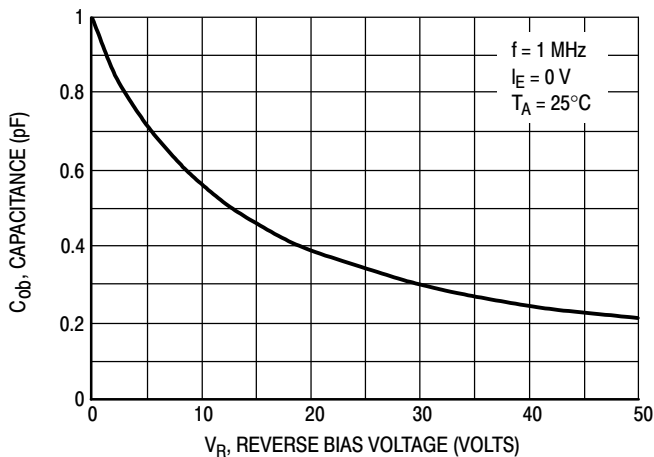

Figure 14. Output Capacitance

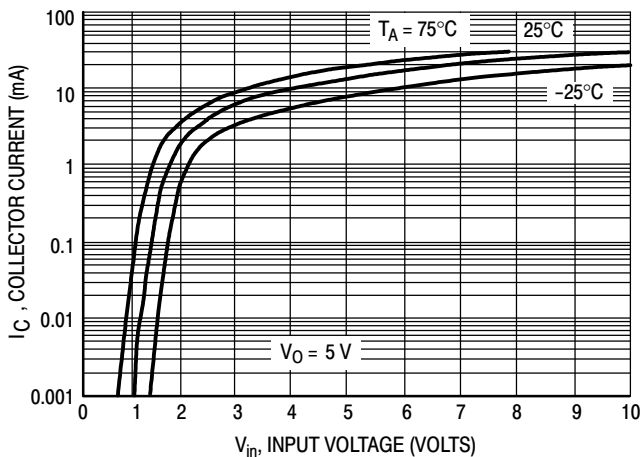

Figure 15. Output Current versus Input Voltage

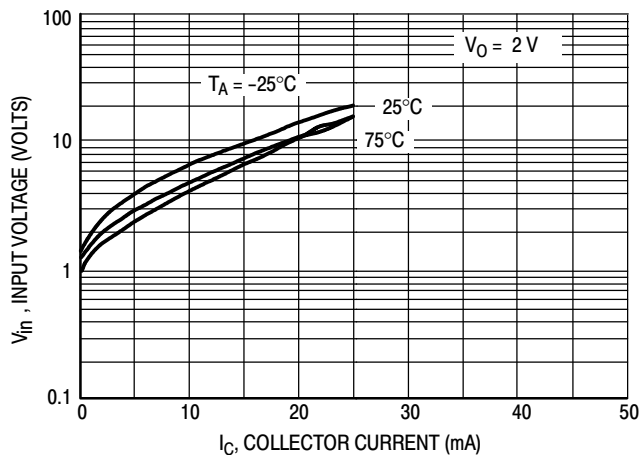

Figure 16. Input Voltage versus Output Current

# MMUN2111LT1G Series

## TYPICAL ELECTRICAL CHARACTERISTICS MMUN2114LT1

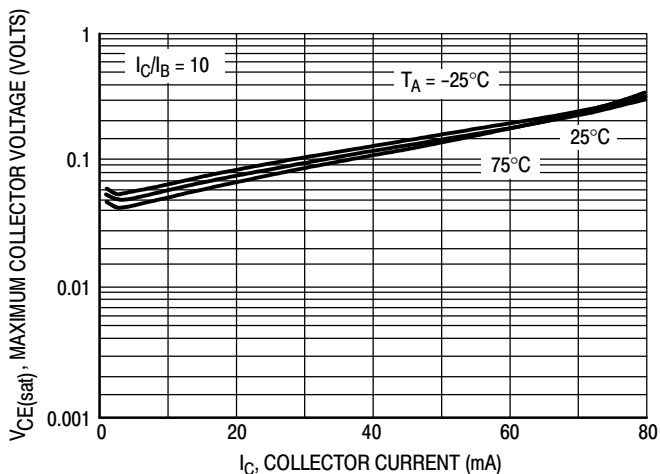

Figure 17.  $V_{CE(sat)}$  versus  $I_C$

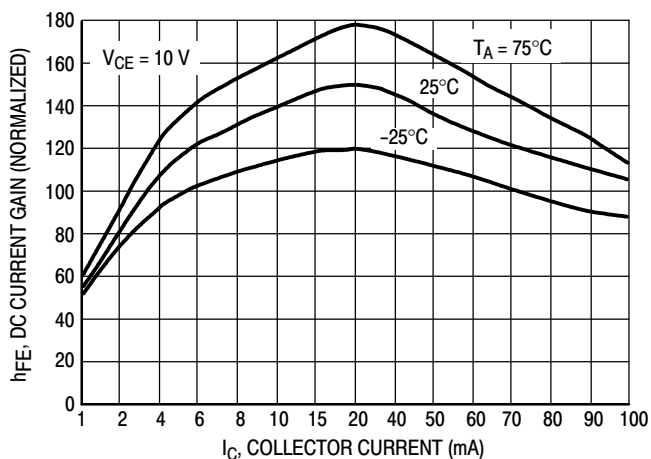

Figure 18. DC Current Gain

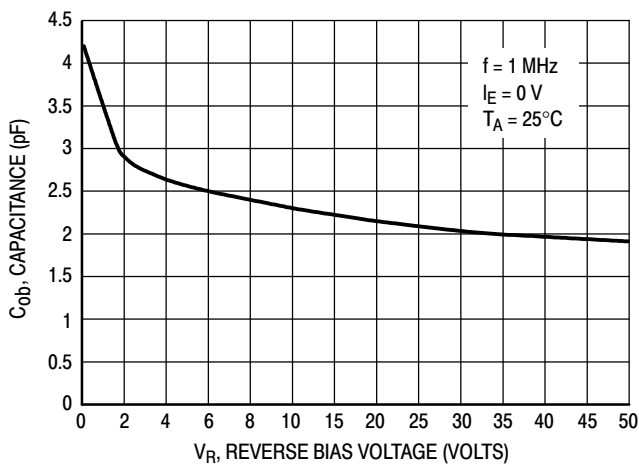

Figure 19. Output Capacitance

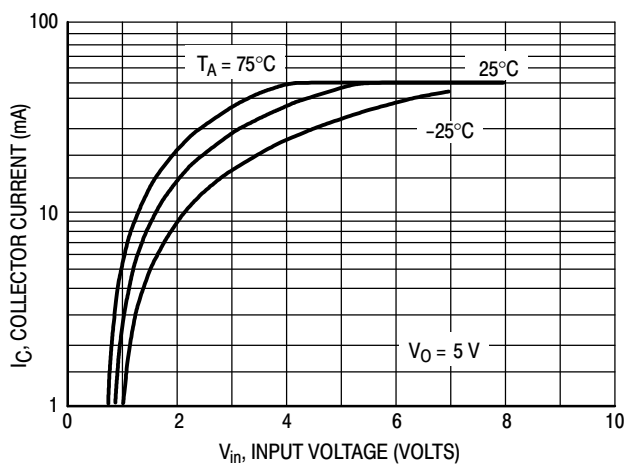

Figure 20. Output Current versus Input Voltage

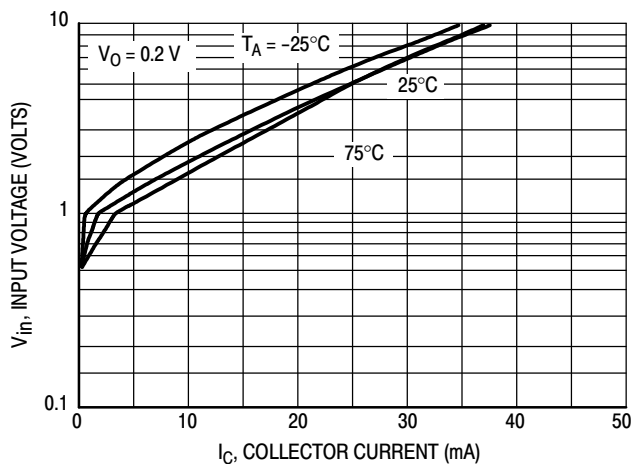

Figure 21. Input Voltage versus Output Current



# MMUN2111LT1G Series

## TYPICAL ELECTRICAL CHARACTERISTICS MMUN2115LT1

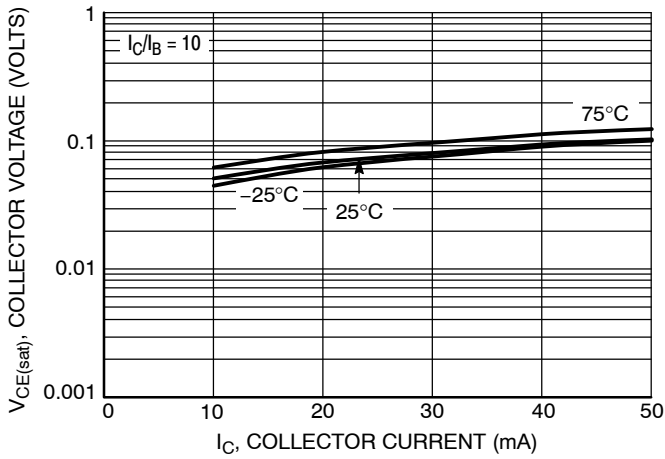

Figure 22.  $V_{CE(sat)}$  versus  $I_C$

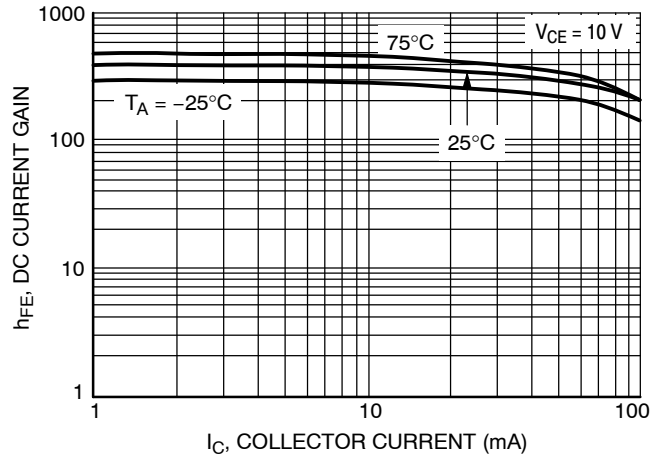

Figure 23. DC Current Gain

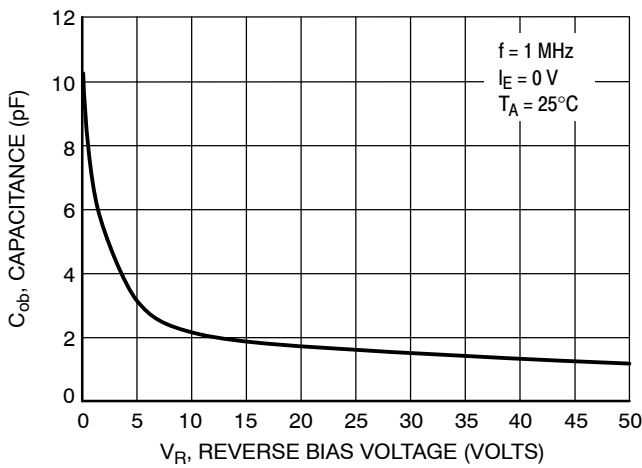

Figure 24. Output Capacitance

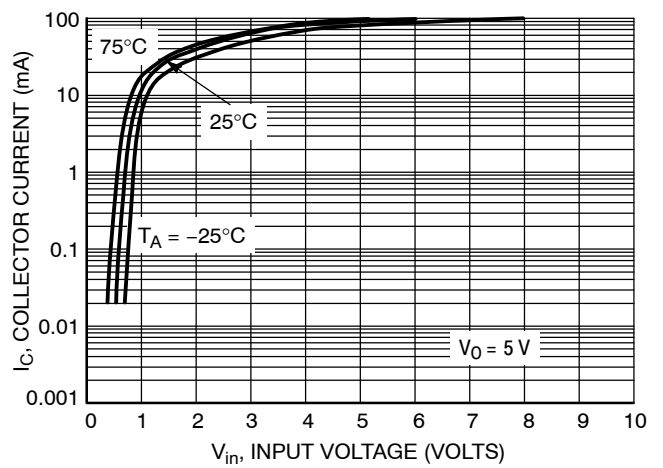

Figure 25. Output Current versus Input Voltage

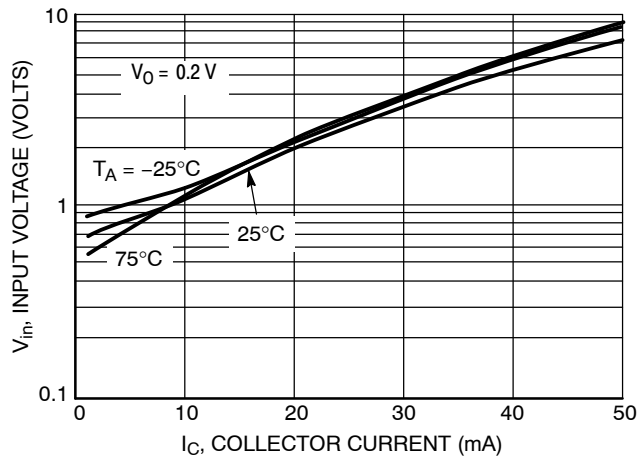

Figure 26. Input Voltage versus Output Current

# MMUN2111LT1G Series

## TYPICAL ELECTRICAL CHARACTERISTICS MMUN2116LT1

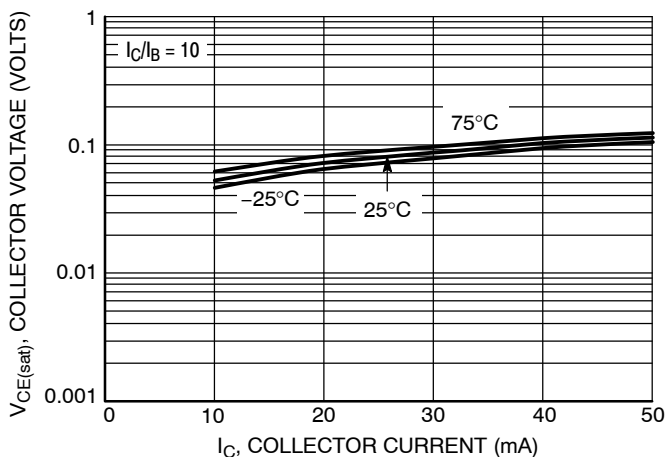

Figure 27.  $V_{CE(sat)}$  versus  $I_C$

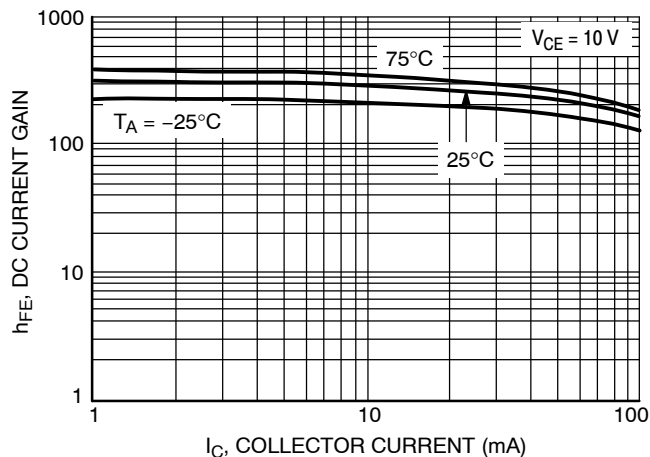

Figure 28. DC Current Gain

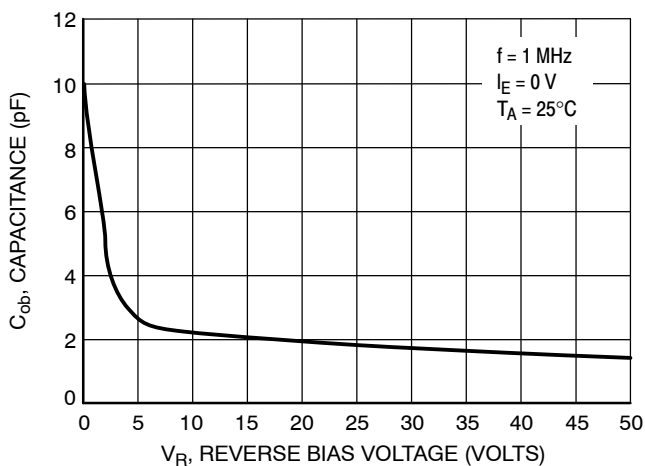

Figure 29. Output Capacitance

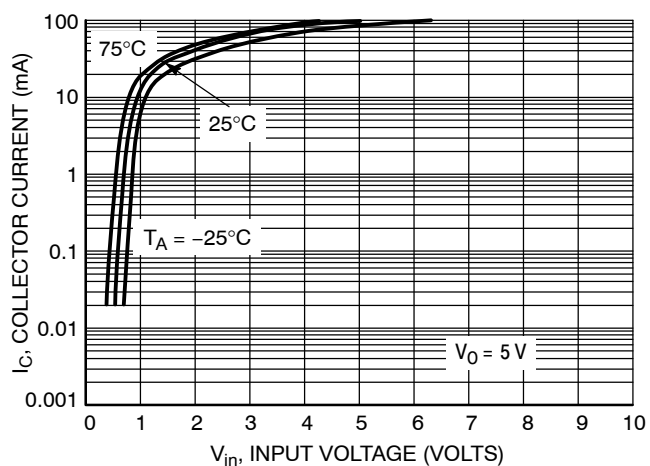

Figure 30. Output Current versus Input Voltage

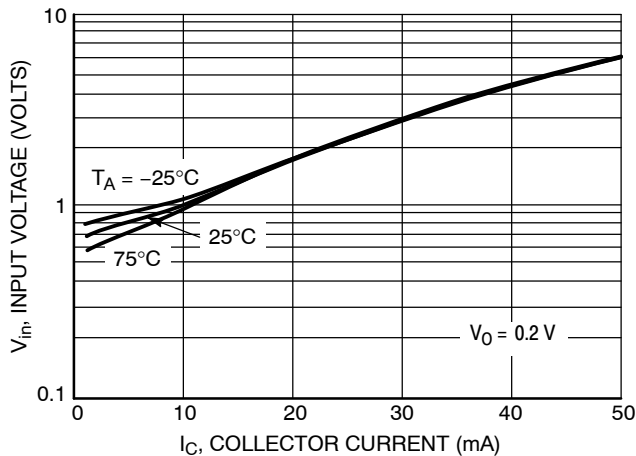

Figure 31. Input Voltage versus Output Current

# MMUN2111LT1G Series

## TYPICAL ELECTRICAL CHARACTERISTICS MMUN2132LT1

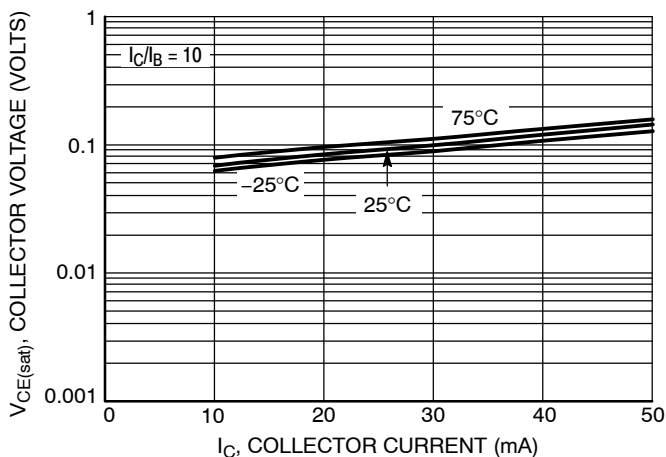

Figure 32.  $V_{CE(sat)}$  versus  $I_C$

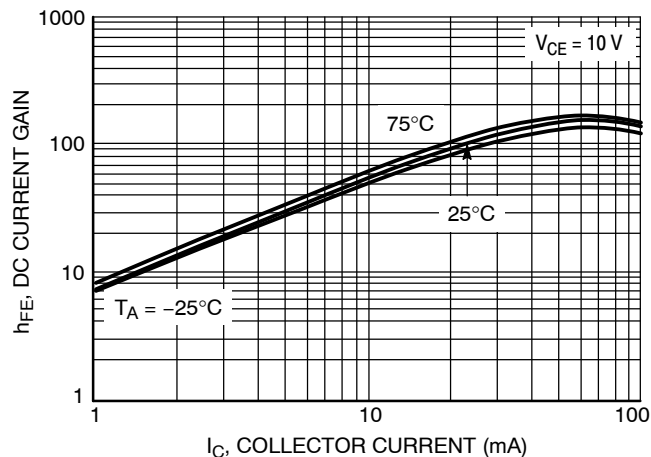

Figure 33. DC Current Gain

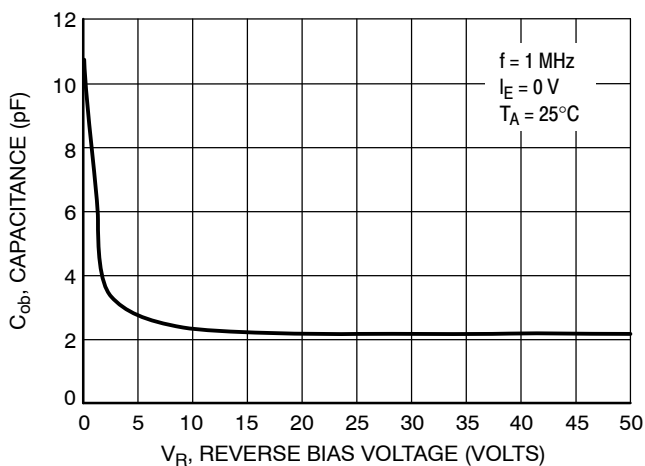

Figure 34. Output Capacitance

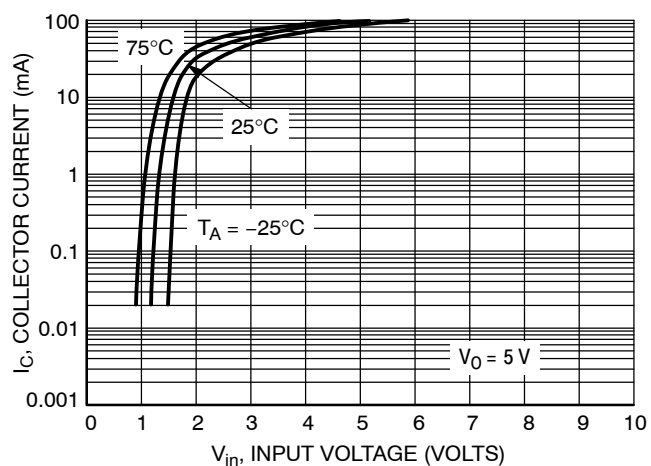

Figure 35. Output Current versus Input Voltage

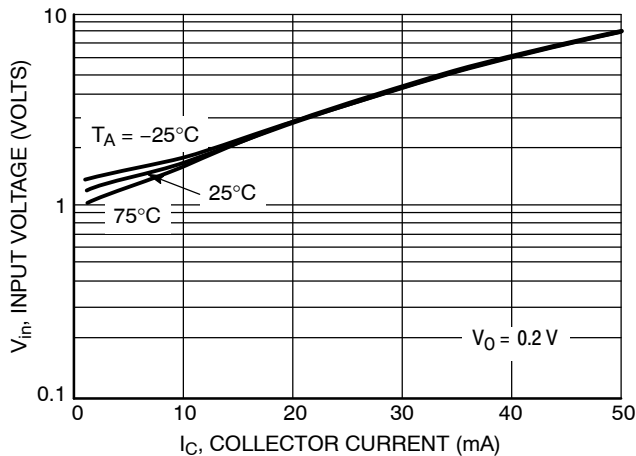

Figure 36. Input Voltage versus Output Current

# MMUN2111LT1G Series

## TYPICAL ELECTRICAL CHARACTERISTICS MMUN2133LT1

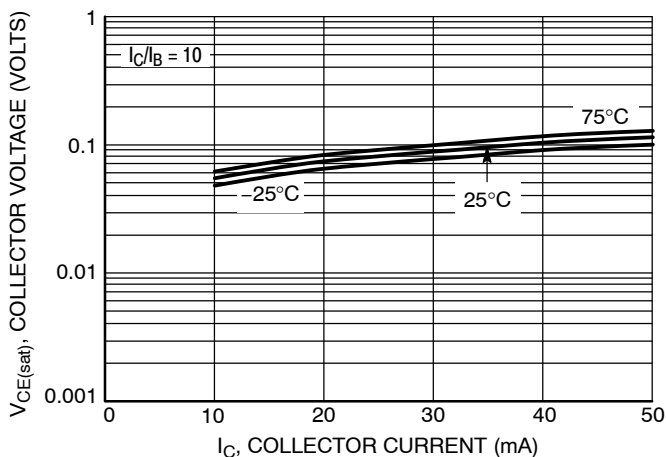

Figure 37.  $V_{CE(sat)}$  versus  $I_C$

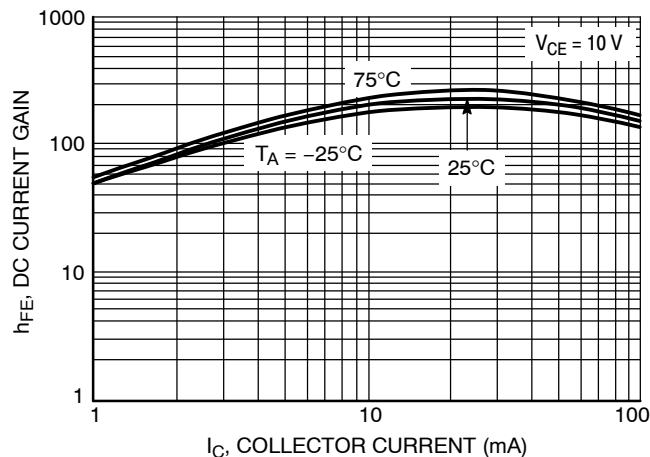

Figure 38. DC Current Gain

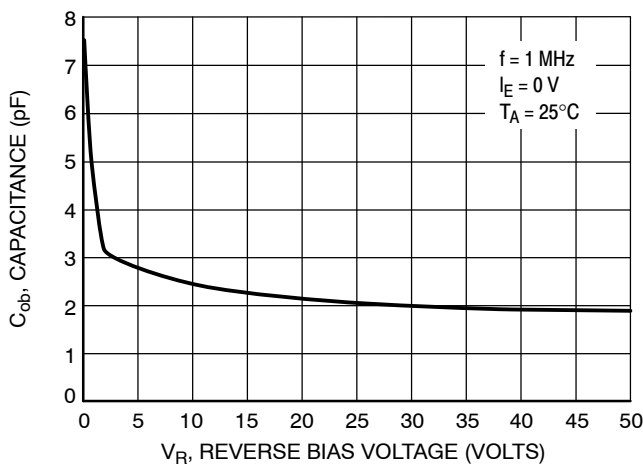

Figure 39. Output Capacitance

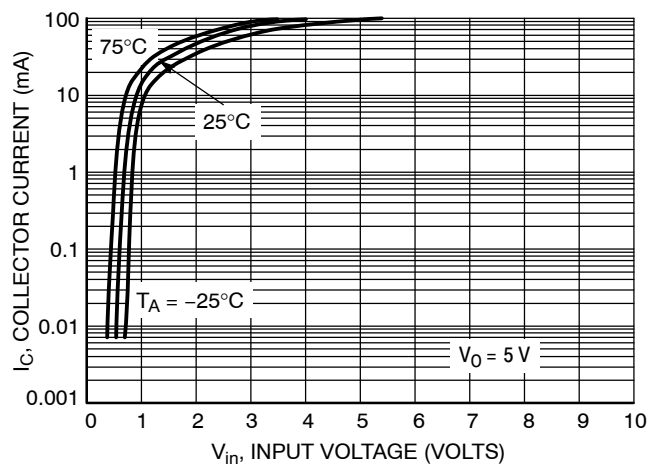

Figure 40. Output Current versus Input Voltage

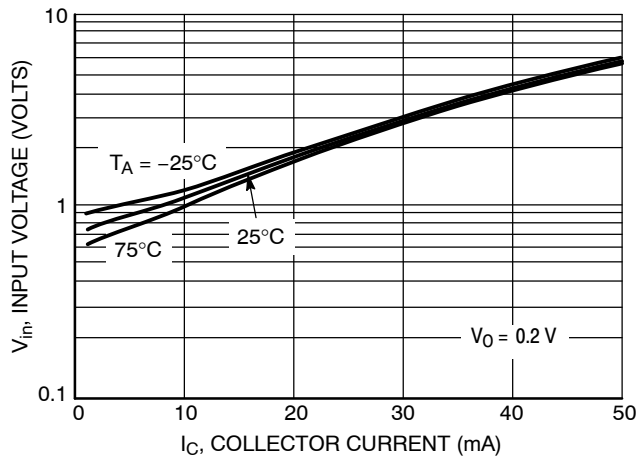

Figure 41. Input Voltage versus Output Current

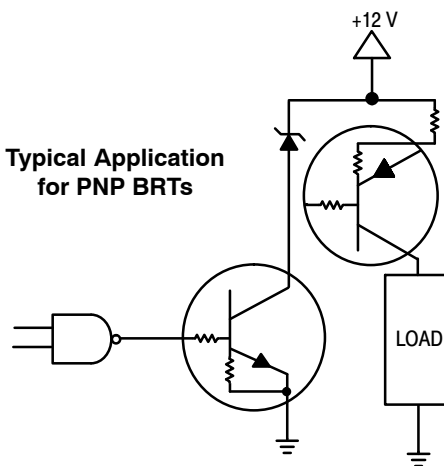
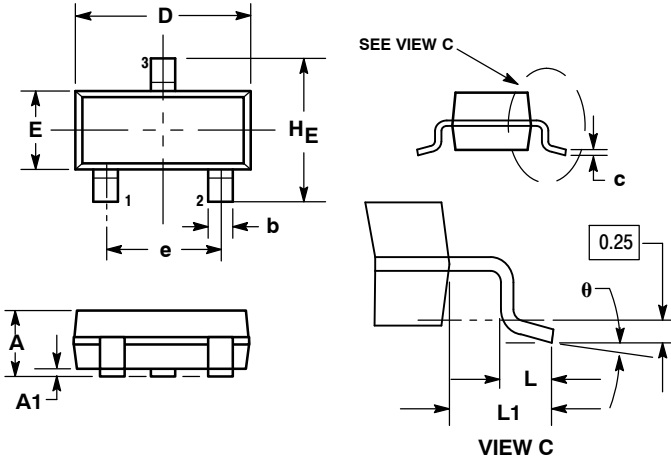

Figure 42. Inexpensive, Unregulated Current Source

# MMUN2111LT1G Series

## PACKAGE DIMENSIONS

SOT-23 (TO-236)  
CASE 318-08  
ISSUE AN



NOTES:

1. DIMENSIONING AND TOLERANCING PER ANSI Y14.5M, 1982.
2. CONTROLLING DIMENSION: INCH.
3. MAXIMUM LEAD THICKNESS INCLUDES LEAD FINISH THICKNESS. MINIMUM LEAD THICKNESS IS THE MINIMUM THICKNESS OF BASE MATERIAL.
4. 318-01 THRU -07 AND -09 OBSOLETE, NEW STANDARD 318-08.

DIM	MILLIMETERS			INCHES		
	MIN	NOM	MAX	MIN	NOM	MAX
A	0.89	1.00	1.11	0.035	0.040	0.044
A1	0.01	0.06	0.10	0.001	0.002	0.004
b	0.37	0.44	0.50	0.015	0.018	0.020
c	0.09	0.13	0.18	0.003	0.005	0.007
D	2.80	2.90	3.04	0.110	0.114	0.120
E	1.20	1.30	1.40	0.047	0.051	0.055
e	1.78	1.90	2.04	0.070	0.075	0.081
L	0.10	0.20	0.30	0.004	0.008	0.012
L1	0.35	0.54	0.69	0.014	0.021	0.029
HE	2.10	2.40	2.64	0.083	0.094	0.104

STYLE 6:

- PIN 1. BASE
- EMITTER
- COLLECTOR

### SOLDERING FOOTPRINT\*

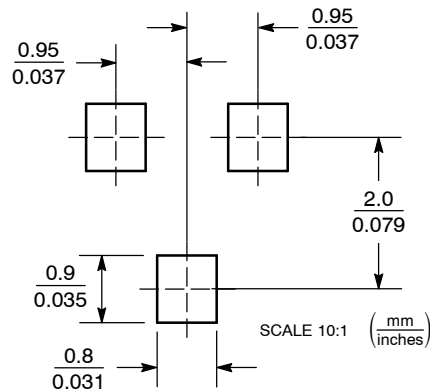

\*For additional information on our Pb-Free strategy and soldering details, please download the ON Semiconductor Soldering and Mounting Techniques Reference Manual, SOLDERRM/D.

ON Semiconductor and are registered trademarks of Semiconductor Components Industries, LLC (SCILLC). SCILLC reserves the right to make changes without further notice to any products herein. SCILLC makes no warranty, representation or guarantee regarding the suitability of its products for any particular purpose, nor does SCILLC assume any liability arising out of the application or use of any product or circuit, and specifically disclaims any and all liability, including without limitation special, consequential or incidental damages. "Typical" parameters which may be provided in SCILLC data sheets and/or specifications can and do vary in different applications and actual performance may vary over time. All operating parameters, including "Typicals" must be validated for each customer application by customer's technical experts. SCILLC does not convey any license under its patent rights nor the rights of others. SCILLC products are not designed, intended, or authorized for use as components in systems intended for surgical implant into the body, or other applications intended to support or sustain life, or for any other application in which the failure of the SCILLC product could create a situation where personal injury or death may occur. Should Buyer purchase or use SCILLC products for any such unintended or unauthorized application, Buyer shall indemnify and hold SCILLC and its officers, employees, subsidiaries, affiliates, and distributors harmless against all claims, costs, damages, and expenses, and reasonable attorney fees arising out of, directly or indirectly, any claim of personal injury or death associated with such unintended or unauthorized use, even if such claim alleges that SCILLC was negligent regarding the design or manufacture of the part. SCILLC is an Equal Opportunity/Affirmative Action Employer. This literature is subject to all applicable copyright laws and is not for resale in any manner.

### PUBLICATION ORDERING INFORMATION

**LITERATURE FULFILLMENT:**  
Literature Distribution Center for ON Semiconductor  
P.O. Box 5163, Denver, Colorado 80217 USA  
**Phone:** 303-675-2175 or 800-344-3860 Toll Free USA/Canada  
**Fax:** 303-675-2176 or 800-344-3867 Toll Free USA/Canada  
**Email:** orderlit@onsemi.com

**N. American Technical Support:** 800-282-9855 Toll Free  
USA/Canada  
**Europe, Middle East and Africa Technical Support:**  
Phone: 421 33 790 2910  
**Japan Customer Focus Center**  
Phone: 81-3-5773-3850

**ON Semiconductor Website:** [www.onsemi.com](http://www.onsemi.com)  
**Order Literature:** <http://www.onsemi.com/orderlit>

For additional information, please contact your local Sales Representative